

CAPP[®]

D E N M A R K

CRP-3X

Orbital Shaker



USER MANUAL

CONTENTS

1. Introduction.....	1
2. Intended Use.....	1
3. Features.....	1
4. Technical Specification.....	2
5. Accessories.....	2
6. Safety Precautions.....	3
7. Installation.....	5
8. Standard Parts Listing.....	7
9. User Interface & display.....	8
10. Optional Attachments.....	10
11. Operation.....	13
12. Warranty Statement.....	17
13. Product Disposal.....	19

1. INTRODUCTION

This manual provides important safety information for this Platform Shaker. It should be kept near the equipment for quick & easy reference. This platform shaker allowstheshaking (Orbital / Linear motion) of liquids & semi-liquids up to a maximum weight of 7.5 Kg. It supports various attachments for mixing liquids in bottles, flask, test tubes and bowls. It is supplied with non-slip mat(Optional) to hold flask and beakers. It comes with the program and sub-program features for various mixing purpose.

2. INTENDED USE

This is shaker is used to mix, blend, or to agitate substances in the tube(s) or flask(s) by shaking them (up to 7.5kg), which is mainly used in the fields of chemistry and biology. A shaker contains an oscillating board which is used to place the flasks, beakers, test tubes, etc. This shaker is a preferred choice of equipment when dealing with such large volume substances, or simultaneous agitation is required.

3. FETAURES

- Shaker with true Orbital / Linear motion, for a shaking of 7.5 Kg mass
- Brushless DC motor for long life and maintenance free operation
- LED display for speed and time adjustment. Speed, time and mode operation can be viewed simultaneously
- Different attachments platform makes it possible to use almost all shapes and sizes of vessels
- Speed ranging from 50 to 500 RPM (for orbital & Linear motion of 10 mm) & 50 to 300 RPM (for orbital & linear motion of 20 mm)
- Program mode allows one to set CW, CCW, Speed, Time, Dwell time, Sequence and Loop operation

3. FETAURES

- Last run memory feature allows easy repeatability in tests

4. TECHNICAL SPECIFICATION

Motor Type	BLDC motor
Orbital/Linear Motion	10 mm / 20 mm diameter
Variable Speed	50 to 500 RPM / 50 to 300 RPM
Run Time	1 min to 99.59 hours
Maximum allowable Weight	7.5 Kg (Including Attachment)
Platform size (LxW)	330mm x 330mm
Protection Rating	IP 21
Permissible ambient Temp.	5°C to 40°C
Permissible relative moisture	<80%
Permissible ON time	100%
Air Pressure	80 to 106 kPa
Noise Level	<60 dB
Weight	10 kg
Dimensions (W x D x H)	408 x 350 x 99 mm
Input Voltage	24 VDC 1.5 A
Power Consumption	24W
RS-232 Interface	Optional

5. ACCESSORIES

1. Power Adaptor
2. Attachments (Optional)
3. Spanner
4. Product User Manual

6. SAFETY PRECAUTIONS

- In order to use this unit properly and safely, every user must first read the operation instructions and follow safety instructions as mentioned below.
- Do not load more than 7.5 Kg of weight
- Wear personal protective equipment before working with shaking unit for user safety
- Never touch moving parts. It can cause mild to serious injuries.
- Always install the unit on the flat, stable and non-slippery surface.
- Do not hold or try to lift the unit with shaking platform.
- Ensure to unplug the power adaptor before cleaning.
- Ensure that the product is used for the specified application only. It should not be used for shaking hazardous or reactive solution.
- It must not be operated in a hazardous or flammable environment and must not be used to mix explosive or highly reactive material.
- Do not use the instrument if it shows the sign of electrical or mechanical damage. If any such damage is found, contact supplier immediately.
- Ensure to firmly tight the shaking attachments. If not done, it can lead to lead to an injury.
- If you notice that the device is not working smoothly then reduce the speed or load till it has a smooth operation.
- In case there is an interruption in power supply during operation, the instrument will not start automatically again when power supply restore.

6. SAFETY PRECAUTIONS

- Furthermore, the shaking unit may only be used to stir those materials or material mixtures that the user knows will not react dangerously to the extra energy produced by the stirring. This also applies to extra energy by means of solar radiation during the shaking procedure.
- The shaker must not be used in explosive atmospheres, for mixing dangerous substances or under water.
- Accessories may only be assembled once the plug has been disconnected. The safety of the user cannot be guaranteed if the appliance is operated with accessories that are not supplied or recommended by the manufacturer or if the appliance is operated improperly, contrary to the manufacturer's specifications.
- Always use the power adaptor recommended or supplied by the manufacturer. If not, it will void the warranty.
- Make sure that all the attachments are attached and tightened properly before performing any operation

7. INSTALLATION

This smart platform shaker is supplied in a box. Open the box, then remove the packaging and gently place the device on the firm & leveled surface. Take care while unpacking & removing all accessories. The user manual should be kept with the device for easy access. Please keep all packaging in safe storage for at least two years for warranty purpose.

3.1 LOCATION

1. Ideal ambient temperature is $20^{\circ}\text{C} \pm 5^{\circ}\text{C}$; avoid placing the shaker in direct sunlight.
2. Keep clearance of at least 30 cm from all direction to guarantee easy and safe operation.
3. Keep away from heat or water to avoid sample temperature issues or shaker failures.
4. Do not place the shaker so that it become difficult to operate the device.

3.2 CONNECTING POWER ADAPTOR

1. Connect one side of power adaptor to rear side of the instrument and other to supply as shown in the figure below.

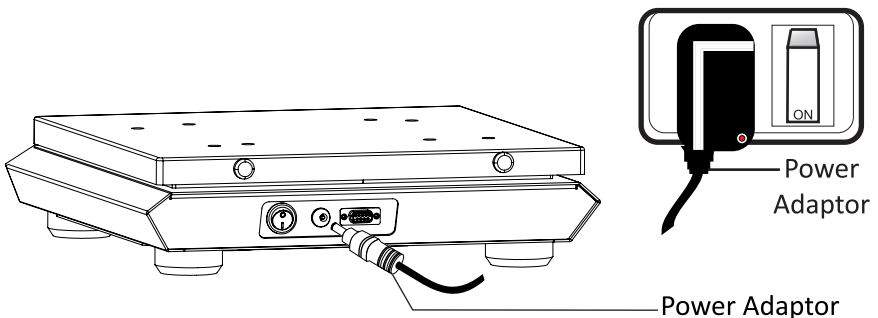

7. INSTALLATION

3.3 MOUNTING

Place the instrument on a flat and leveled surface; ensure that the four feet of this shaker stand on the surface firmly. Avoid installing on a slippery surface or surface prone to vibration. If the mounting surface is uneven, adjust the appropriate base mount of the instrument by moving downward or upward. Turn the base mount in the clockwise direction to move the base mount upwards and turn the base mount in the counter-clockwise direction to move the base mount downwards.

To avoid automatically loosening of base mount, hold the base mount with one hand and tighten the nut of base mount using a spanner. Tightening of the nut is in clockwise direction and loosening in the counter-clockwise direction. Please make sure that the instrument is leveled on a mounting surface for efficient and safe operation.

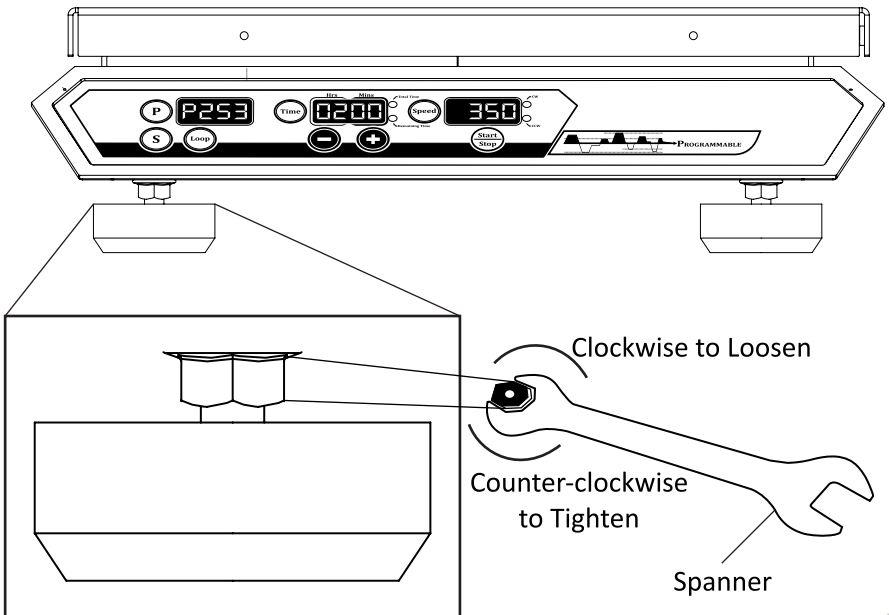

8. STANDARD PARTS LISTING

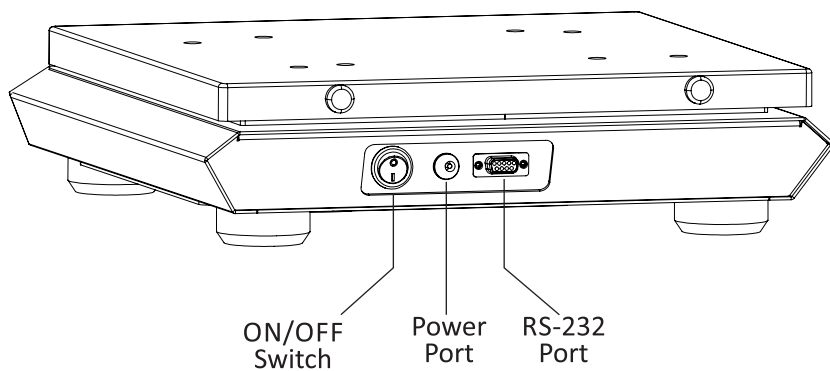
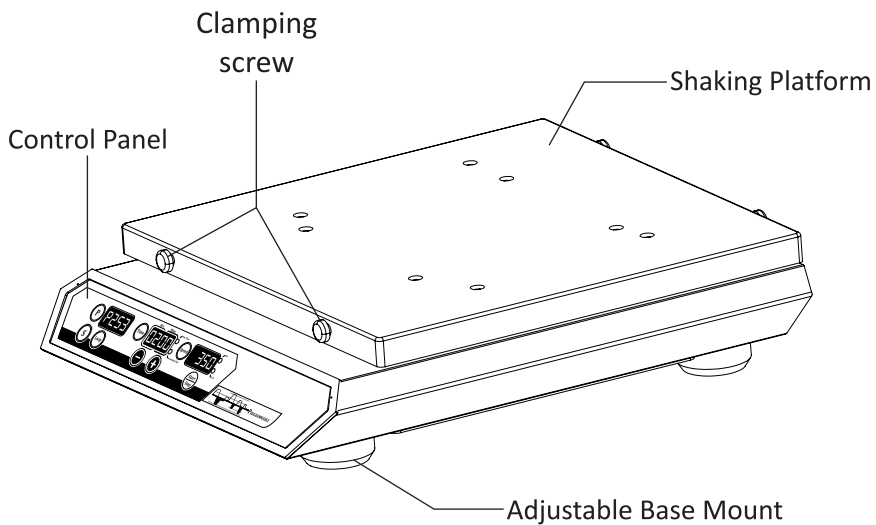

9. USER INTERFACE AND DISPLAY

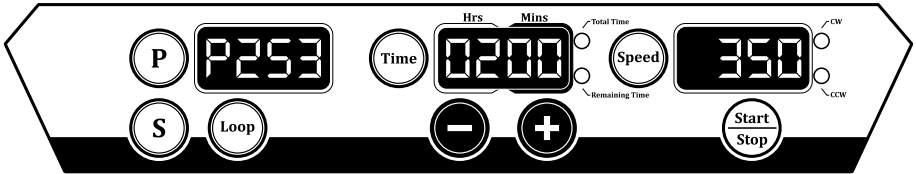

Speed Section



Speed button, Speed value display and CW/CCW direction selection LED.

- Press Speed button to select and set speed value.
- Clockwise and counter-clockwise LED allows the user to select the direction of the rotation. Press SPEED button to select speed with CW direction of rotation. Press SPEED button again to select speed with CCW direction of rotation. By default, the direction of rotation is CW.

Time Section



Time button, Time value display, Total time and Remaining time indication LED.

- Press Time button to select and set Time value in Hours & Minutes. The 1st press allows the user to select the time in “minutes” and long press allows the user to select the time in “hours”.
- Total Time and Remaining Time LED will glow only during operation. Both LEDs will glow alternatively.

(+) & (-) Section



Increment and Decrement Buttons.

- Increment (+) and Decrement (-) buttons are used to increment or decrement speed, time and program value.

9. USER INTERFACE AND DISPLAY

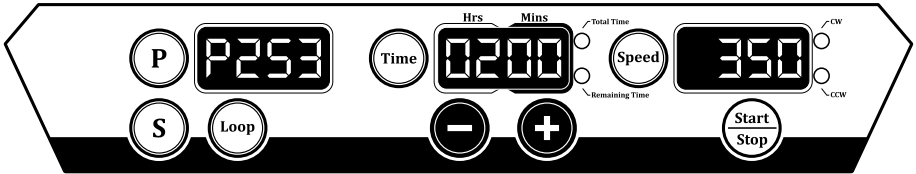

Program Mode Section

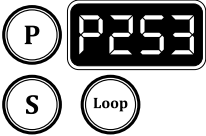

Program (**P**) button, Sub-Program (**S**) button, Loop button and its corresponding display.

- Long Press Program button (**P**) to enter or exit from program mode
- Single Press Program button (**P**) to select programs.
- Single Press Sub-Program Button (**S**) to select Sub-Programs.
- Single Press Loop Button to Loop the sub-programs of particular program

Start/Stop Button



Press Start / Stop button to start and stop operation.

10. OPTIONAL ATTACHMENTS

Optional attachments are used for shaking of liquids in flask, funnel, tubes, bottles etc. All these attachments easily get placed and tighten on the shaking platform.

Below are the optional attachments with its name and usage.

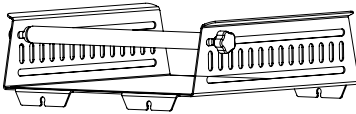

Universal Attachment

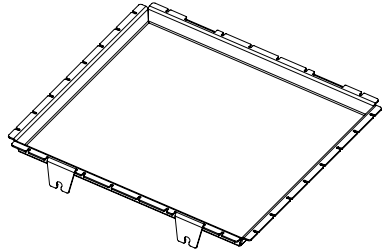

Disc Attachment

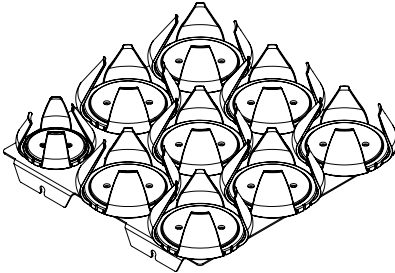

Flask Attachment

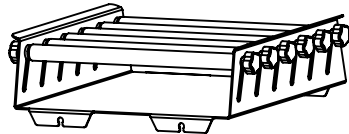

Funnel Attachment

10. ATTACHMENTS INSTALLATION

10.1 Installing & Removing Universal Attachment

All attachments must be firmly placed on the shaking platform. Make sure that unit is OFF while you place the attachment on the platform. Properly hold the attachment with both the hands and place it on the shaking platform.

Guide all four (4) holding bracket in such a way that it placed on the respective clamping screws. Once the attachment is placed on the clamping screw tighten all four (4) clamping screws.

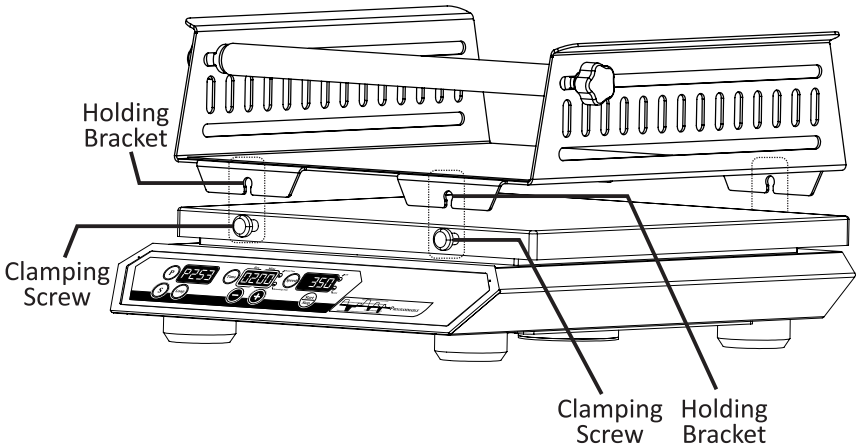

Removing Attachment:

To remove the attachment, loosen the clamping screw and lift up the attachment.

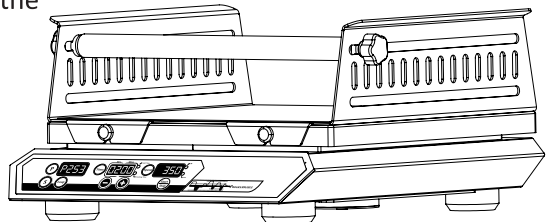

Note:

- 1) Do not place any flask or beaker or any liquid material on the attachment while placing on the shaking platform.
- 2) Hold the attachment carefully with gloves for user protection.

10. SUPPORTING WEIGHT ON ATTACHMENTS

In order to ensure safe and secure operation, the shaking platform must only be operated within the range of usable weight and speed (see diagram). Please make certain that the platform surface on which the attachment is placed is clean and leveled.

If the attachment is screwed together with an adjacent piece of equipment (i.e. if it is integrated into a system) it should be noted during operation that dynamic forces may arise as a result of unfavorable loading circumstances and the position of the center of gravity. This may cause the adjacent equipment to vibrate or may cause the table to vibrate uncontrollably. If you notice that the device is running unevenly, in that case, consider lowering the speed till the irregularities fade out.

Make sure that individual attachment vessels are placed in the middle of the attachment and multiple vessels are evenly placed on the attachment. Also, ensure that all the vessels are firmly fastened on the attachment.

Load VS Speed (Universal Attachment)

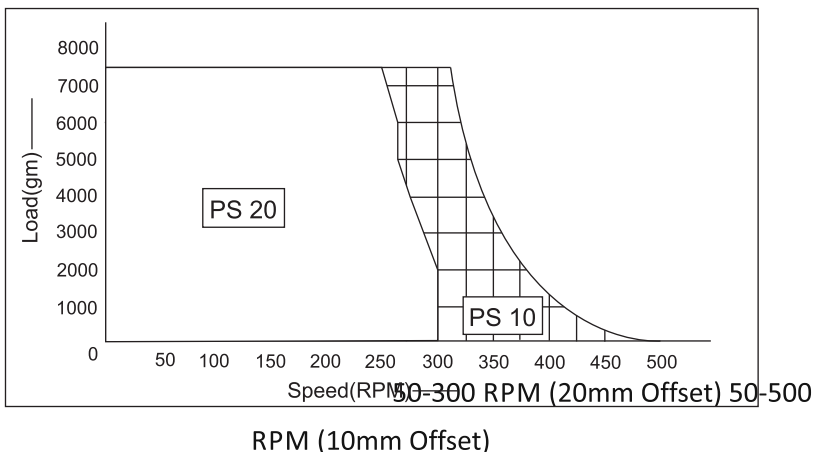

11. OPERATION

11.2 SETTING TIME

Single press “Time Button” to select Time value. On 1st press, the “Minutes” value will be selected and on the second time, the “Hours” value will be selected. Minutes and Hours value will toggle on each press. Once the required value is selected, use increment and Decrement buttons to modify and set the new time.

Once the operation starts, timer value in the display will toggle showing “Total Time” and “Remaining Time” once set RPM is reached.

Timer value can't be modified or change during operation.

11.3 START AND STOP OPERATION

Once the required speed and time values are set, press “Start Button” to start operation. Unit starts slowly and set RPM is reached.

Press “Stop Button” is pressed, the unit will stop steadily.

11.4 PROGRAM MODE

Program mode is a feature used to run shaker in user define mode.

For Example: If a user has a requirement for a specific type of shaking like:

- 1) 250 RPM shaking in clockwise direction for 2 minutes then
- 2) Hold of 1 minute then
- 3) 400 RPM shaking in counter clockwise direction for 4 minutes and so on.

This kind of specific shaking is achieved using program mode or program section.

There is a total of 6 Programs available from P1 to P6. Each of this program has 9 sub-program from S1 to S9 and a Loop mode for continuous or repetitive operation.

11. OPERATION

Program mode Flow chart. Each Program has 9 different Sub-Programs and all 9 sub programs can have different speed and time values. Looping of each program can be done using Loop Button.

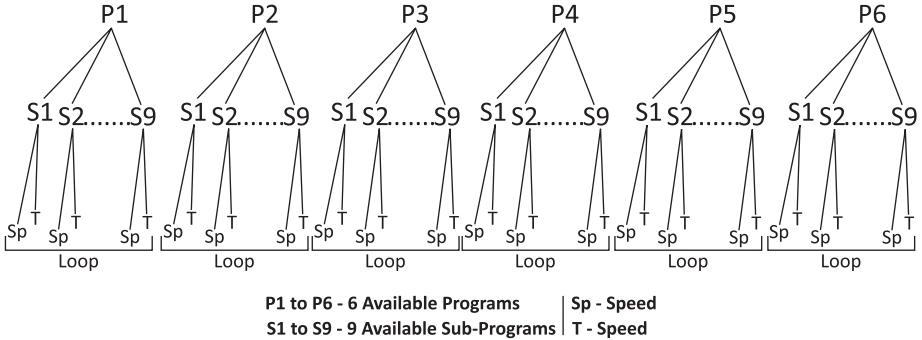

Initially, there will be no display in the program mode indicating that shaker is running or operated in normal mode.

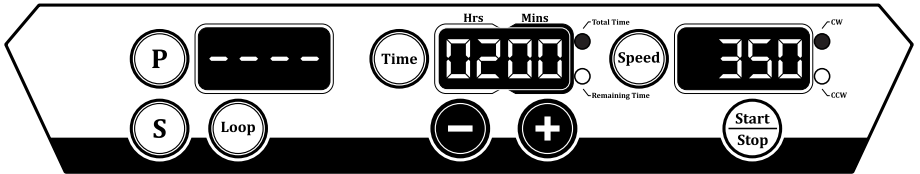

Long Press Program mode “P” to enter into Program mode. Once entered, below display will be seen.

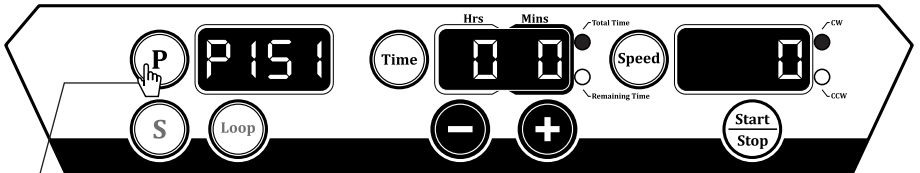

Long Press

Above image show that shaker is entered into program mode and currently Sub-Program - 1 “S1” of Program 1 “P1” is selected. Both speed and time value is zero (0) for this program.

11. OPERATION

Single Press Program Button “P” to select program. Program value will start blinking and the user can use increment or decrement button to select any program from available 6 programs.

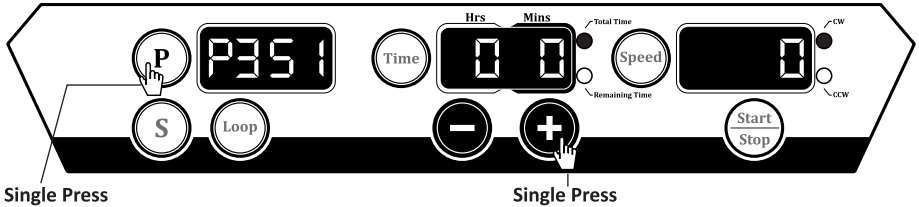

Single Press Sub-Program Button “S” to select sub-program. The sub-program value will start blinking and the user can use increment or decrement button to select any sub-program from available 9 programs.

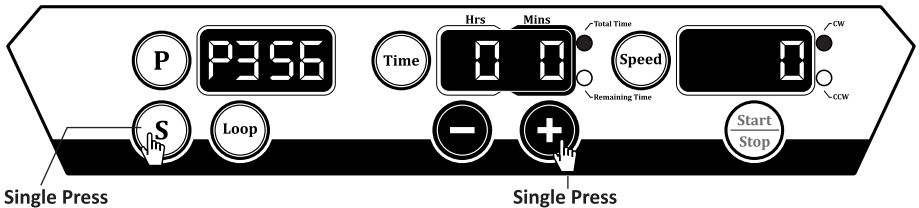

Once the required sub-program is selected, use speed and time buttons to set required speed and time values.

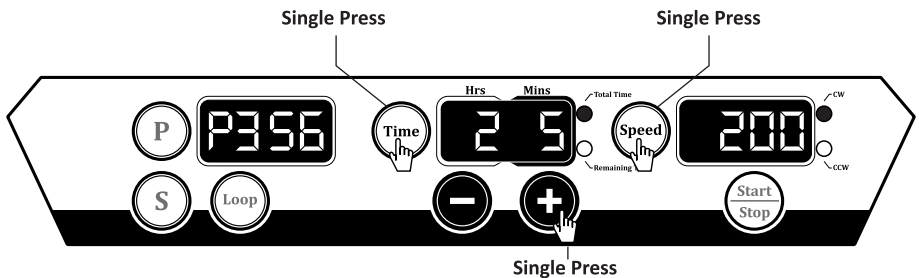

In this way, the user can set different speed and time values for different sub-programs. The user can also set a type of rotation i.e. either clockwise or anti-clockwise rotation for that particular speed or time.

11. OPERATION

Press “Loop Button” to make the loop of sub-programs. The display will show “SL” indicating Loop is selected. The user can set total time of Loop by press “Time Button”.

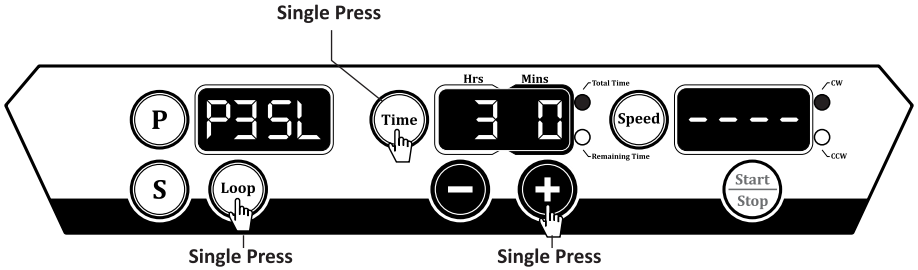

The above image shows that the loop of Program 3 “P3” is created and that loop will go on for 3 hours.

Press start button to start operation. The operation will start for that particular program from 1st sub-program.

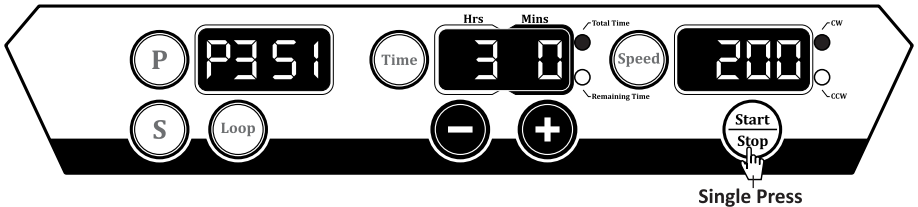

Operation starts with 1st sub-program and goes to last sub-program which is set. The loop of sub-program goes on for total time set.

Press “Stop Button” to stop program mode operation.

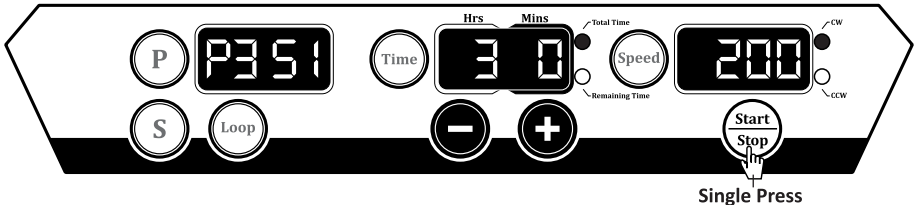

12. WARRANTY STATEMENT

This product is warranted to be free from defects in material and workmanship for a period of two (2) years from the date of purchase. Your product will be duly repaired upon prompt notification in compliance with the following conditions:

This warranty is valid only if the product is used for its intended purpose and within the guidelines specified in this instruction manual. This warranty does not cover damage caused by accident, neglect, misuse, improper service, natural forces or other causes not arising from defects in original material or workmanship. This warranty does not cover any incidental or consequential damages, commercial loss or any other damages from the use of this product.

The warranty is invalidated by any non-factory modification, which will immediately terminate all liabilities on us for the products or damages caused by its use. The buyer and its customer shall be responsible for the product or use of products as well as any supervision required for safety. If requested the products must be returned to the distributor in well packed and insured manner and all shipping charges must be paid.

Some states do not allow limitation on the length of implied warranties or the exclusion or limitation of incidental or consequential damages. This warranty gives you specific legal rights. This warranty is given expressly in lieu of all other warranties, expressed or implied.

12. WARRANTY STATEMENT

The purchaser agrees that there is no warranty of merchantability or of fitness for any intended purpose and that there are no other remedies or warranties, expressed or implied, which extend beyond the description on the face of the agreement. This warranty is only applicable to the original purchaser.

Products received without proper authorization will not be entertained. All items returned for service should be sent postage prepaid in the original packaging or other suitable cartons, padded to avoid damage. We will not be responsible for damage incurred by improper packaging.

All items returned for service should be set postage prepaid in the original packaging or other suitable carton, added to avoid damage.

This warranty is valid only if the warranty is registered with the supplier within 30 days from the date of purchase.

13. PRODUCT DISPOSAL

In case the product is to be disposed of, the relevant legal regulations are to be observed.

Information on the disposal of electrical and electronic devices in the European Community

The disposal of electrical devices is regulated within the European Community by national regulations based on EU Directive 2012/19/EU on waste electrical and electronic equipment (WEEE). According to these regulations, any devices supplied after 13.06.05 in the business to the business sphere, to which this product is assigned, may no longer be disposed of in municipal or domestic waste. They are marked with the following symbol to indicate this.



As disposal regulations within the EU may vary from country to country, please contact your supplier if necessary.



Landbrugsvej 10 | DK 5260 | Odense S | Denmark

Tlf +45 6613 6140 | Fax +45 6613 2770

www.capp.dk | info@capp.dk